

## SHENZHEN KEWO ELECTRIC TECHNOLOGY CO., LTD

### About us



KEWO is a Chinese famous manufacturer of AC drives, solar pump inverter, also focus on automation solution providing and renewable energy technologies offering. The company employ about 200 people and set up service centers in approximately 25 provinces in China.

**KEWO AC DRIVES,**

**VARIABLE FREQUENCY DRIVE,**

**FREQUENCY INVERTER**

**FOCUSING ON MOTOR DRIVES FOR 20 YEARS**



**ADD:** 3 Floor,Block 8,St George Industrial Park,Xinyu Road,Sha Jing,Bao'an, Shenzhen, Guangdong, China, 518104.

Tel: 86-755-23283620, Fax: 0755-23283620, MP: 86-13725501611; 86-13249062939.

Web: [www.kewodrive.com](http://www.kewodrive.com).

Email: [service@kewodrive.com](mailto:service@kewodrive.com)

## Company introduction:

**KEWO ELECTRIC TECHNOLOGY CO., LTD.** ( hereinafter called KEWO ) is a professional manufacturer of kinds of AC drives, variable frequency inverter, soft start, and solar pump inverter, etc. We are not only focus on designing, manufacturing, sales and after sales service for above mentioned products, but also providing custom made automation solution and renewable energy technologies.

There are more than 150 staffs working in our factor, 60% of them are engineers. Thanks to our great R&D team hardworking and innovation, we mastered core and leading vector control technology for PMSM and IM.

We also introduced and absorbed latest servo motor control and motor control technology from abroad, that help us keep top position among Chinese manufactures. We have established 2 modernization production lines, digital quality control system, code bar tracking system and EPR management system, etc. And every piece of KEWO products have been tested with full load to ensure 100% good quality. Quality begins and ends with each person in our company.

KEWO products is comprised of high level AC drives, variable speed drive, frequency inverter, solar pump drive with DC and AC input, etc. These products are widely using in industrial automation, cement, textile, metallurgy, HVAC, oil & gas, water treatment, chemical , machine tools, hoisting, agriculture, farming, irrigation...



KEWO factory



Reception room



Production line

## KEWO Products Range: (VSD, Frequency Inverter, Servo drive, soft starter, solar pump Inverter)



AD100 (VFD)

AD350(VFD)

AD800( Vector Control Inverter)









Sealed VFD

AD850Z/T( Servo Drive)

Solar Pump Inverter

Soft Starters

## KEWO AD DRIVES BRIEF INTRODUCTION

PRODUCTS	SPECIFICATION	PICTURES	BRIEF INTRODUCTION
AD800 Series High Performance Vector Control Drive/ <b>Variable Speed Drive</b>	1Ph, 220V, 0.4kw to 2.2kw. 3Ph, 220V, 0.75kw to 75kw 3Ph, 380V/660V/1140V, 0.75 to 630kw.		Drive for PMSM and IM Accuracy speed and torque control for motor, multiple functions, good protection; Sensorless vector control, sensor vector control with PG, VF control, 180% rated starting torque, big allowance IGBT module ,
AD100 Mini Economic AC Drive	1Phase, 220V, 0.4 to 1.5kw		Adopt software platform as same as AD800, easy using and powerful function Mini and Economic type, Using IPM of iGBT
AD350 Mini Vector Control Drive	1 Ph 220V,0.4 to 2.2kw, 3 Ph,380V, 0.75 to 3.7kw		Mini drive with compact design Vector control and VF using the same software platform as AD800; IGBT module to ensure good quality, rich functions
Ad800S Frequency Inverter For PMSM (servo drive)	1Ph, 220V, 0.4kw to 2.2kw. 3Ph, 220V, 0.75kw to 75kw 3Ph, 380V/660V/1140V, 0.75 to 630kw.		Enhanced AD800 version, special for PMSM servo motor with sensorless or sensor control, Multiple protection function Rich functions, and flexible using PG card built in controller board
AS850 Z Servo Drive For PMSM Of IMM.	3 phase, 380V±15%, 5.5kw to 110kw		Driving f or permanent magnet synchronous motor (PMSM) for energy saving. High energy saving, high power factor, quick response and high accuracy control, etc.
AS850T Spindle Servo Drive For PMSM And IM	3 phase, 380V±15%, 2.2kw to 55kw		Spindle servo drive for CNC, machining center, packing, textile, etc. high accuracy speed, torque and position control through close loop servo control
SD800 Seal Frequency Inverter (IP54)	220V (single-phase power) 0.4-2.2kW 380V (three-phase power) 0.75-30kW		sealed frequency inverter is enhanced version of AD800 series frequency inverter, built in with IP54 protection grade. With excellent in anti-dust, water proof, anti-grease and anti-corrosion properties

## AD100 Mini Frequency Inverter.

AD100 is a small and economical type inverter, which designed for small machine OEM general purpose application. The good performance of V/F control mode, multiple segment speed, flexible and accuracy PID, DC braking function, ModBus communication, that will make you machine become powerful and improving his competitive edge.

**Power range:** 0.4 to 1.5kw

**Input voltage:** single phase 220V  $\pm$ 15%

**Control mode:** Sensorless vector control without PG, V/f control

**Protection function:** Provide up to 25 kinds fault protection, over current, over voltage, under voltage, phase missing, overload protection function

**Cooling method:** force cooling

**Installation method:** wall mount

**IPM IGBT using**



Good performance for smaller machine.

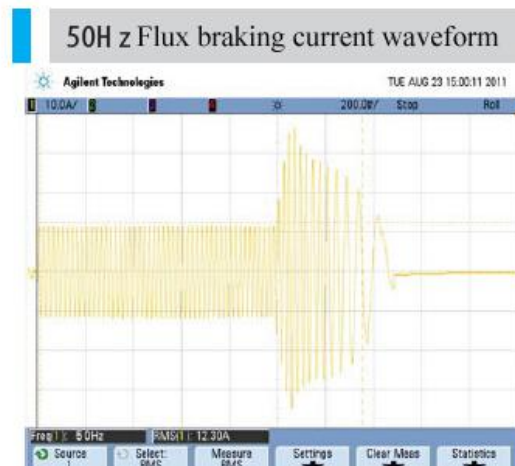
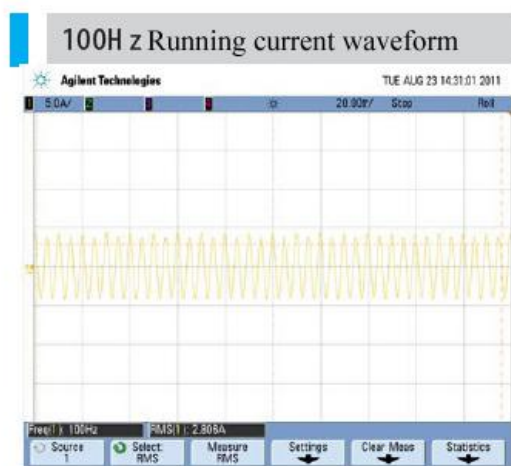

Built in RS485 interface for forming communication easily.

All series support Modbus communication

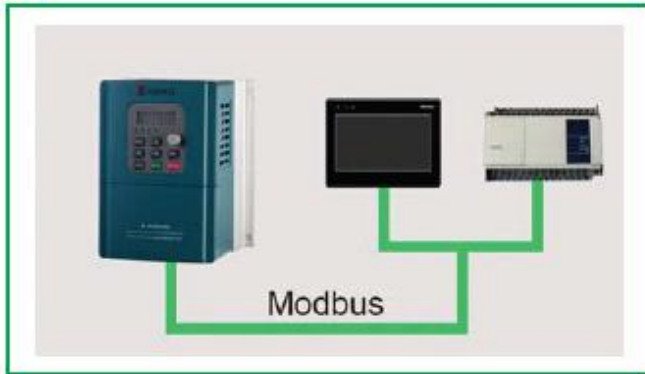

Multiple keypad connection is available



Data sheet.

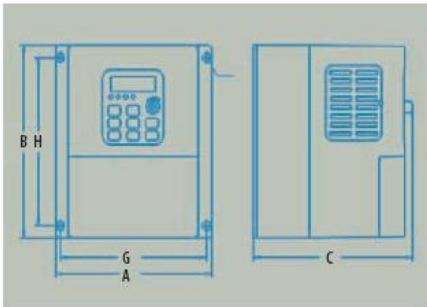

Modes	G	H	A	B	C
AD 100-250.4-2.2G	117	135	125	155	130
AD 350-250.4-2.2G AD 350-4T0.75-3.7G	117	135	125	155	130
AD 350-5.5-7.5G	...	...	...	...	...
AD 350-11-15G	...	...	...	...	...

## Wiring diagram

It has 5 digital input, DI5 can use for high pulse train input.  
2 analog signal input,  
1 analog output and  
1 relay output.

**Terminals diagram:**

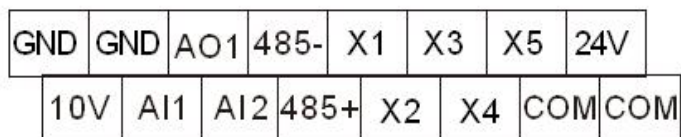

Wiring diagram see AD350 chapter.

## AD350 High Performance Sensorless Vector Control Inverter

AD350 high performance vector control mini frequency inverter is KEWO independently developed new generation general purpose electrical motor controller, which adopt the same software platform as same as AD800.

With a new generation of high-performance advanced vector control technology applying, high torque control even under low speed, high speed precision, quick torque response and high speed range are available for sophisticated motor control.

It is featured to have modular design, small size, small temperature rise, low noise, and reliable performance. It has built in simple PLC, PID adjusting, programmable input and output terminals function, RS458 terminals, multi function analog input and output function. ect.

**Power range:** 2S 0.4 to 2.2kw, 4T 0.75 to 3.7kw.

**Input voltage:** Single phase 220V, 3 phase 380V  $\pm 15\%$

**Control mode:** Sensorless vector control without PG, V/f control

**Protection function:** Provide up to 25 kinds fault protection, over current, over voltage, under voltage, phase missing, overload protection function

**Cooling method:** force cooling

**Installation method:** wall mount

**Infineon IGBT module**



AD350 Sensorless Vector Control Inverter

### Products dimension

#### Data sheet



AC drive models	Install lot mm		Dimension mm			Bolt mm	Reference.
	G	H	A	B	C		
AD350 series							
AD350-2S0.4GB~ AD350-2S2.2GB	117	135	125	155	130	M4	Fig.1
AD350-4T0.75GB~ AD350-4T3.7GB							

**Products features:**

AD350 inverter has the same software and same operation manual as AD800.  
Only the size and I/O layout is difference.

Clear silk print of terminal mark easy for wiring

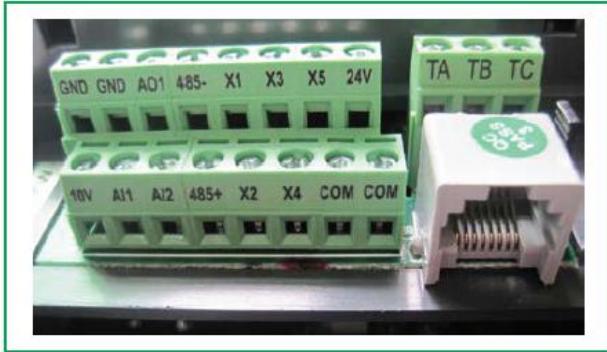

Adopting new generation IGBT module,  
all Kewo AC drive usnig IGBT module for quality guarantee.



Flanging design for easy installation

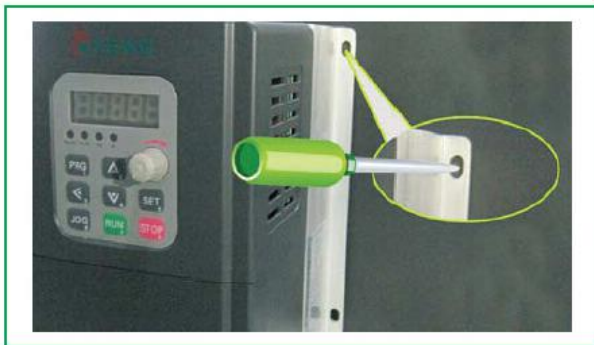

Thick PCBA coating for hard environment using

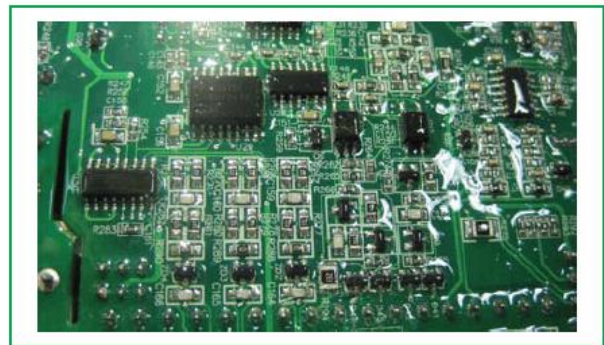

Heat sink and bottom housing together for better heat dissipation,  
the side anti-dust cloth is option.



Bunit it braking unit for full power range of AC350.

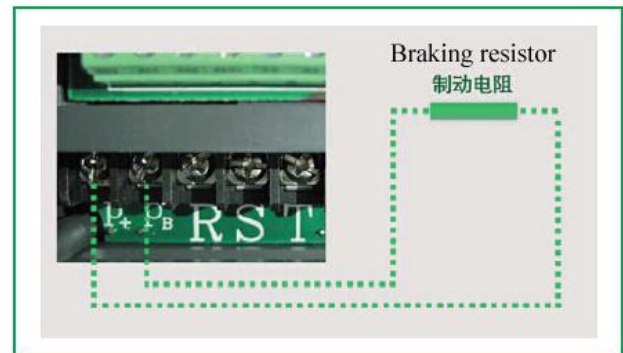

\*AD350 sensorless vector control inverter can't performance close loop vector control because there are no PG connector.

## Wiring diagram

It has 5 digital input, DI5 can use for high pulse train input

2 analog signal input,

1 analog output and 1 relay output.

In built Rs485 terminal

### Terminals diagram:

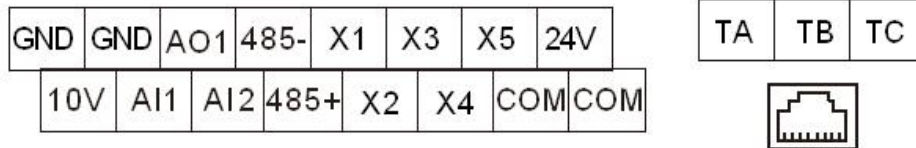

### Wiring diagram.

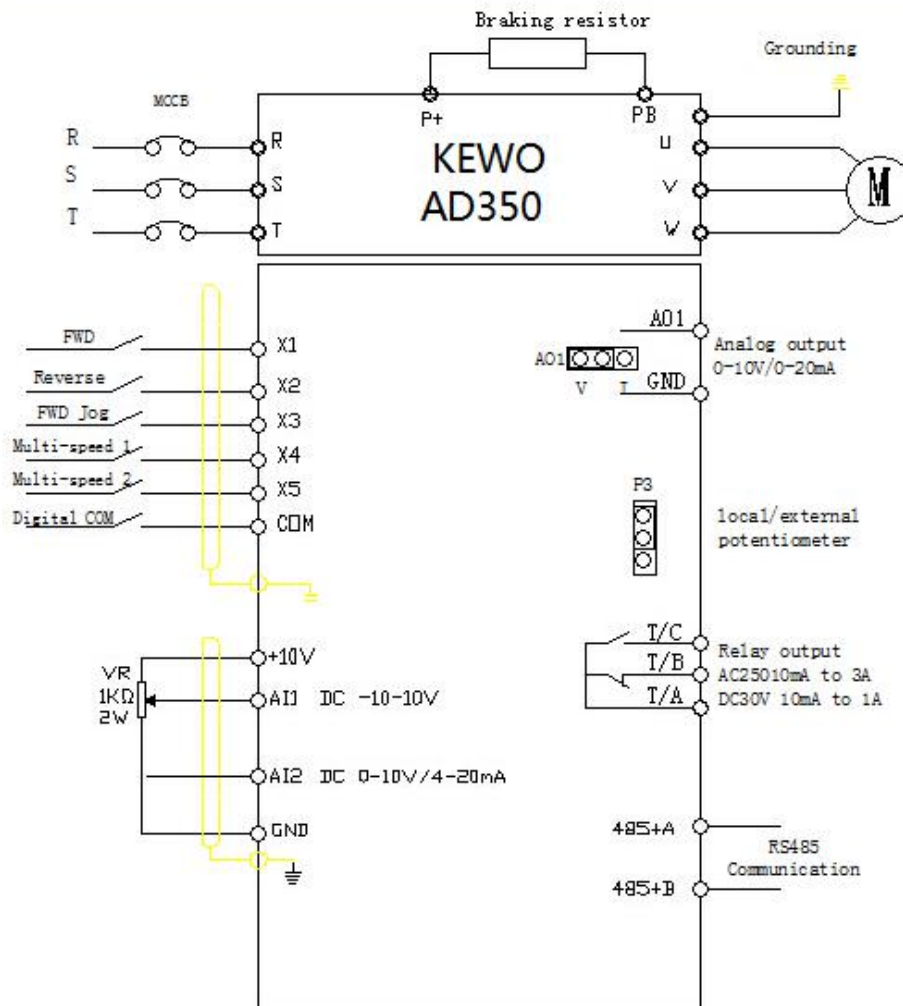



## AD100/AD350 frequency inverter application examples.

### 1. Food processing machinery

Bakery equipment, confectionary equipment, tea-making machine, noodle-making machines, candy-wrapping machines, rice/barely milling machines, flour milling machines, food mixers, food slicers, fruit sorting machines, etc.

#### Advantage:

- You can set the operating frequency according to the required work rate.
- Run and Stop keys.
- Ensures safety in the event of an instantaneous power failure.
- Low noise
- High torque from start up to the rated speed.

### 2. Conveyance machinery

Conveyors, automatic warehousing systems etc. Prevent the collapse of cargo on the conveyor.

The AD100/AD350 allow you to mitigate the shocks caused in starting and stopping a conveyor and change the acceleration /deceleration rates according to the conveyor characteristics and its applications.

The AD100/AD350 can slow down a high –inertia machine in a short period of time without causing an overvoltage trip by increasing the energy consumed by the motor.

The AD100/AD350 can turn on and off the braking circuitry in accordance with the inverter operating status.

It offers vector control and automatic torque boost control modes to achieve strong, stable torque from the start of a motor to the rated speed.

### 3. Fans & pumps

Built in fans- pumps in industrial machines, water supply and sewage systems, driers, etc.

#### Energy-saving mode

The variable torque and automatic energy saving modes help saving energy by passing optimal current in accordance with the load.

#### Automatic process control

Allows a motor to keep running and accelerate smoothly upon the recovery of power even in the event of instantaneous power failure.

**Enable an uninterrupted operation without causing a trip.**

### .4 Health, medical and nursing care equipment.

Stair lifts, nursing bed, bubble baths, health care equipment, medical equipment

### 5. Environment and daily-life-related machinery

Commercial ironing boards, car washing machines, Garbage disposers, dust collectors, Dries, etc.

### 6. Packing machinery.

Inner packaging machine, packing machines, output packing machines, membrane packing machines

The AD100 economic VFD share the same software plat, the same cover, same size and same manual.  
The big difference is power board difference.  
AD100 use IPM IGBT, but AD350 use the iGBT module.



AD350 use iGBT module.

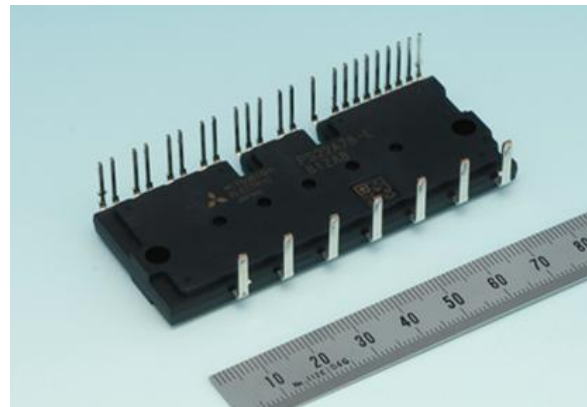

AD100 using the IPM iGBT, but AD350 use Infineon IGBT module

So the AD350 can used in hot temperature for a long time, and have longer service life span compare to AD100.  
AD350 have single phase 220V and 3 phase 220V model.  
AD350 have 4T, 380V model from 0.75kw to 4.0kw.

But AD100 only have single phase 220V input, 0.75kw to 1.5kw.